

Montageanleitung für Duschkabine

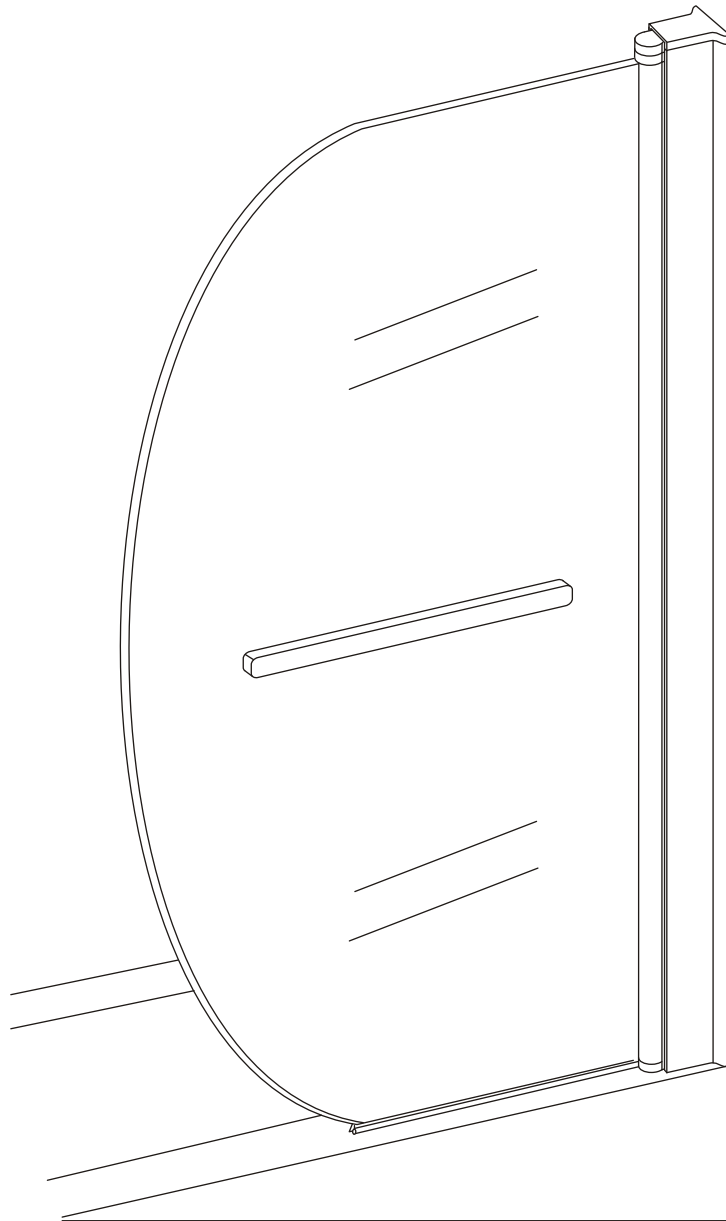

3509

RoHS **CE** **ISO9001:2000**

Benötigtes Werkzeug

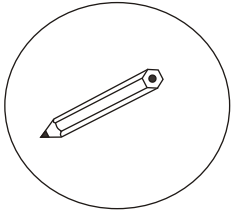

Bleistift

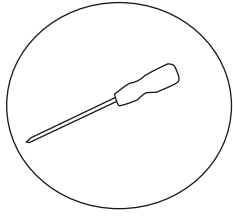

Schraubendreher(Kreuz)

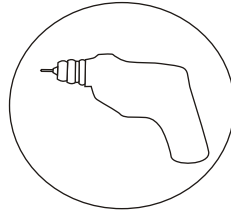

Bohrmaschine

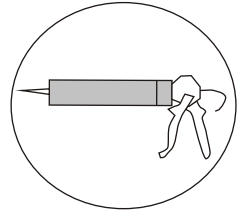

Silikongel

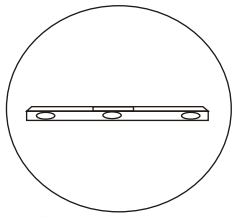

Wasserwaage

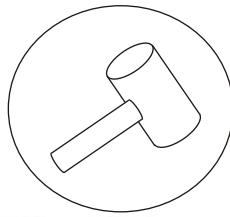

Gummihammer

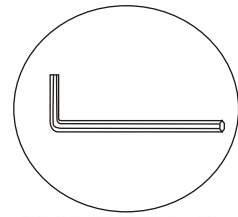

Imbusschlüssel

Teieliste

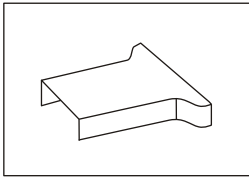

PJ-4643

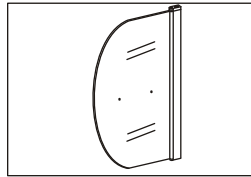

Glaswand

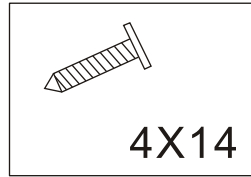

Profil-Schraube

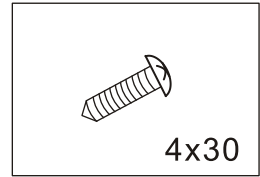

Wand-Schraube

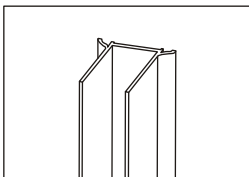

Wand U-Profil

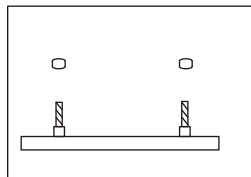

LS-1004

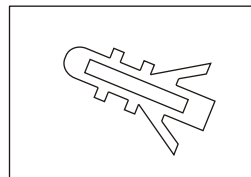

Wand-Dübel

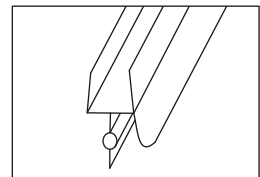

CT-6YXJT-025

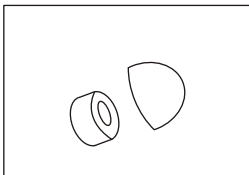

PJ-4553

1. Stellen Sie das U-Profil vertikal an die gewünschte Stelle und nehmen Sie eine Wasserwaage zur Hilfe (siehe Bild).

Markieren Sie die Bohr-Löcher.

2. Bohren Sie an der Markierung und setzen Sie die Dübel in die Löcher.

3. Schrauben Sie das U-Profil an die Wand.

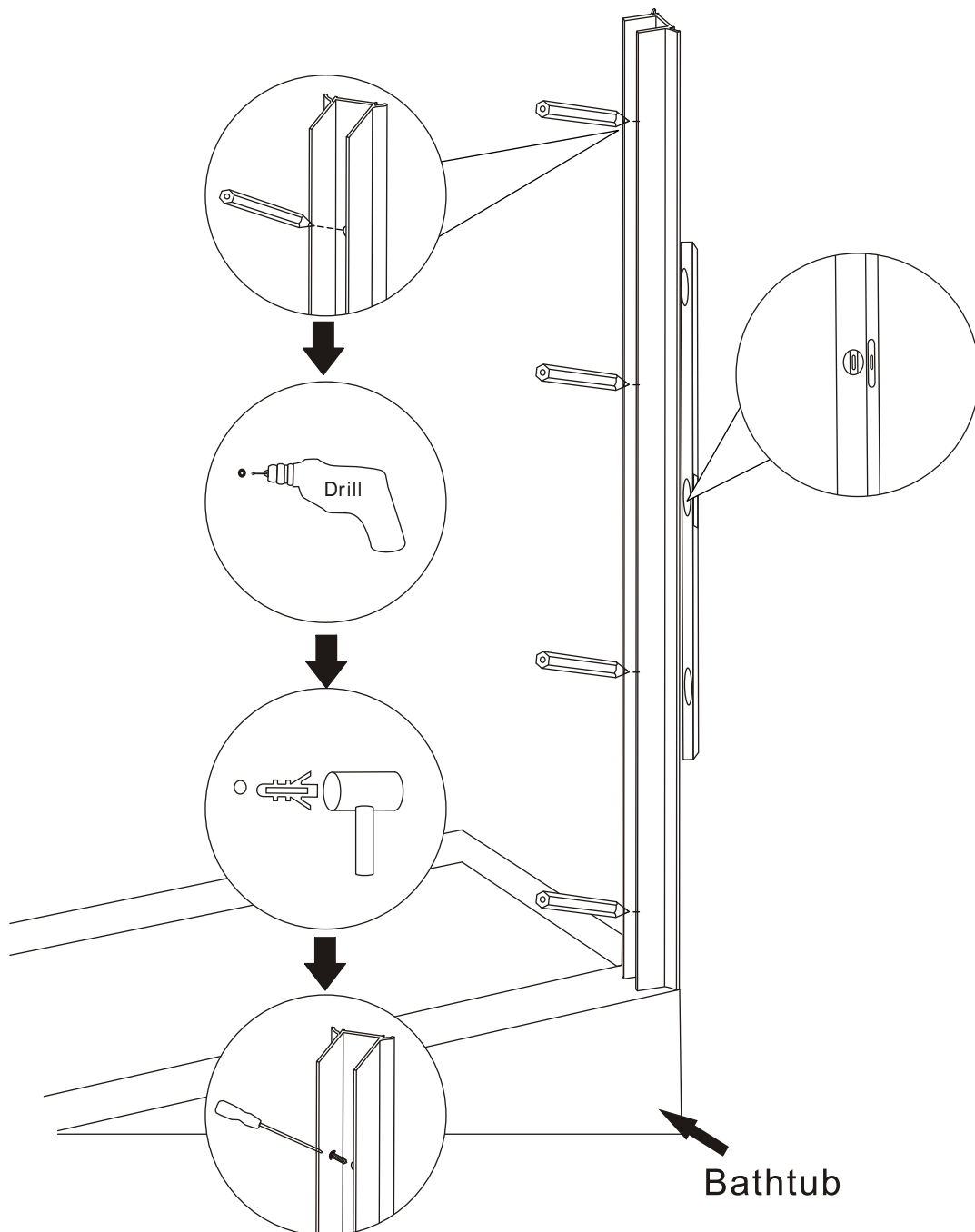
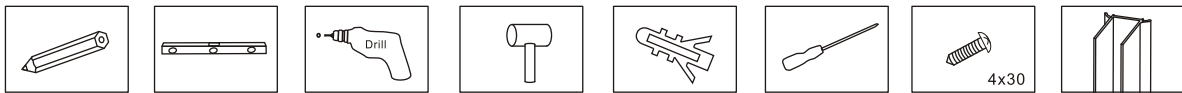

1. Fügen Sie die Bodendichtung an der Tür

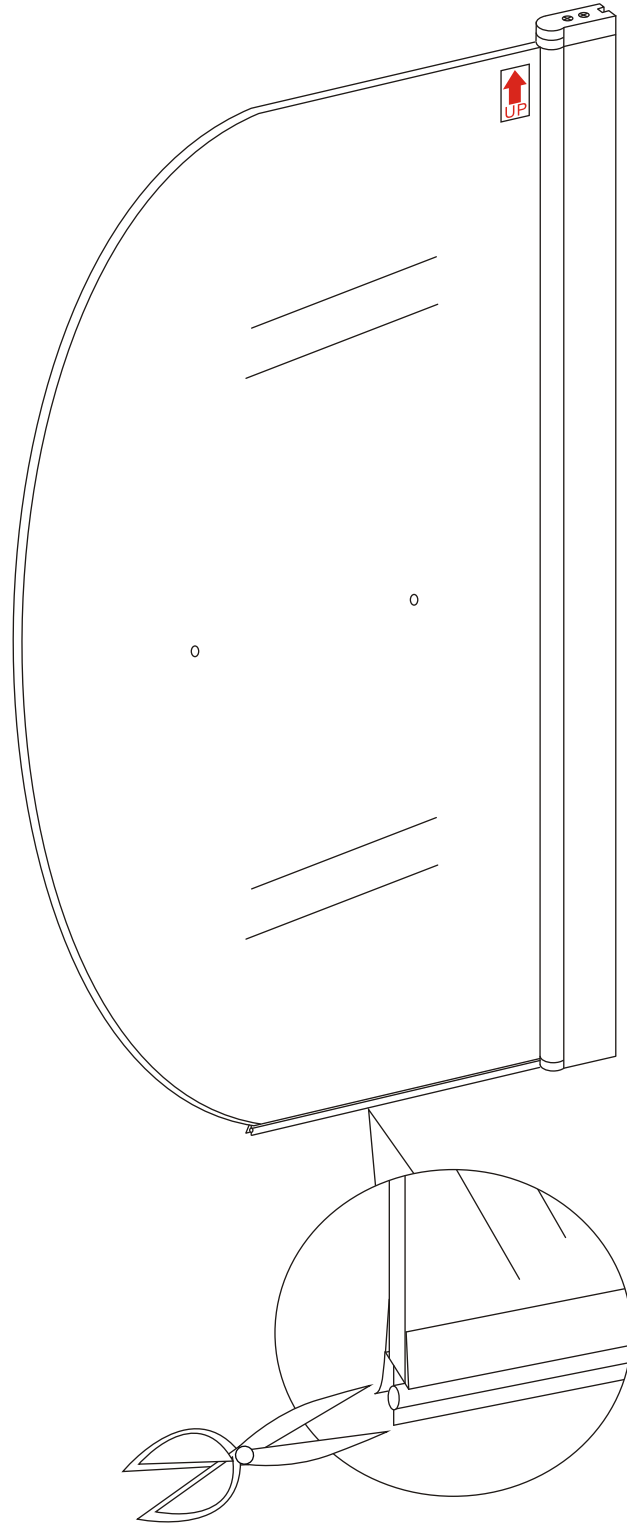
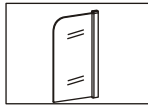
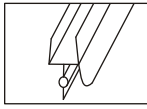

1. Führen Sie die Tür in den Wand-Profil.



Bitte achten Sie beim Aufstellen der Glas-Tür immer auf eine weiche Unterlage.

1. Befestigen Sie das Profil von innen.

2. Installieren sie die Abdeckungen auf dem Profil.

3. Installieren Sie den Türgriff

